

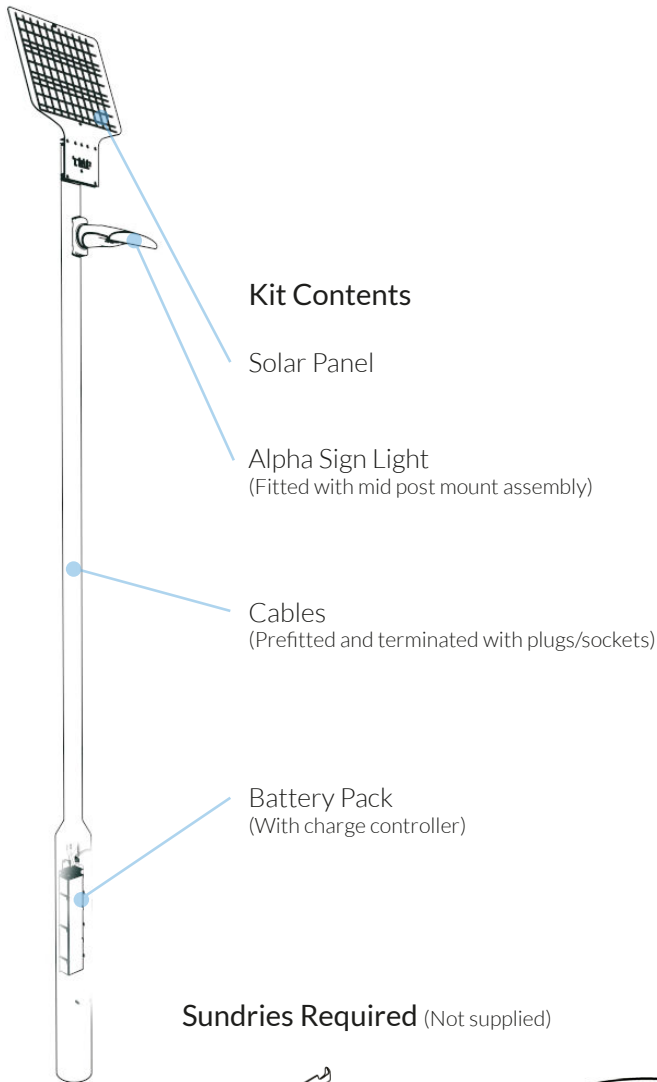

Alpha Solar Installation Guide



Kit Contents

- Solar Panel
- Alpha Sign Light
(Fitted with mid post mount assembly)
- Cables
(Prefitted and terminated with plugs/sockets)
- Battery Pack
(With charge controller)

Tools Needed (Not supplied)

- Gloves and appropriate PPE
- Compass
- Column key
- Drill with 10mm bit
- 13mm Spanner
- Column cutting tool

Sundries Required (Not supplied)

- 2 x Sign Channel Brackets
- Post Cap (internal style)
- 2 x 10mm Grommets
- 2 x Jubilee Clips



IMPORTANT: This product is to be installed and maintained by qualified personnel only. TMP Solutions take no responsibility for damage or injury incurred during the installation or maintenance.

It may be possible to install the kit on a 76mm diameter column, but access apertures vary in size and shape and not all 76mm diameter columns will be suitable. The installer is responsible for checking that the chosen column is structurally suitable for the application and that the kit fits.



Safety

Electrical safety: The nominal voltage is 12V dc, therefore the system is inherently safe. The maximum system voltage is approximately 20V dc from the solar module when it is not connected to a load.

Batteries: The battery pack weighs approximately 8.4 kg, proper manual handling should be observed throughout the installation.

Explosives: The batteries produce a small amount of hydrogen gas whilst charging, and for some time after. Hydrogen is explosive in a wide range of concentrations of air so it is important to ensure the lighting column is well vented. If the access cover forms a seal, drill a 10mm vent hole.

Fire: The batteries have a low internal resistance and will generate a lot of heat when short-circuited. The battery packs are equipped with a 3A fuse which must only be replaced by an identical fuse (automotive, 3A, mini-blade).

Chemical Burns: The batteries contain sulphuric acid which can cause skin and eye damage if it leaks out of a damaged battery. In case of contact seek professional medical advice immediately.

1



Choose an un-shaded location.

2

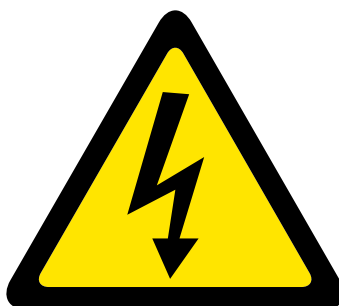

If using an existing column make sure any mains power connections have been removed or terminated.

3

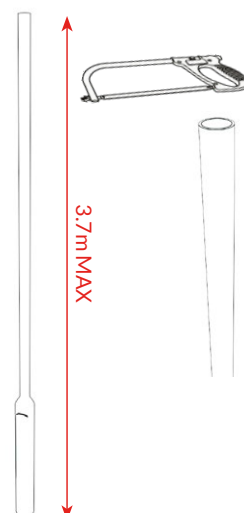

Cut post to maximum 3.7m

4

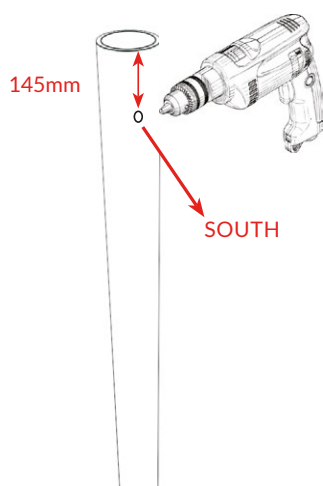

Drill 10mm hole in column 145mm from top facing due SOUTH

5

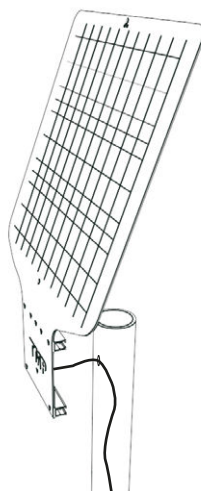

Feed wire from solar panel through hole in the column (use grommet)

6

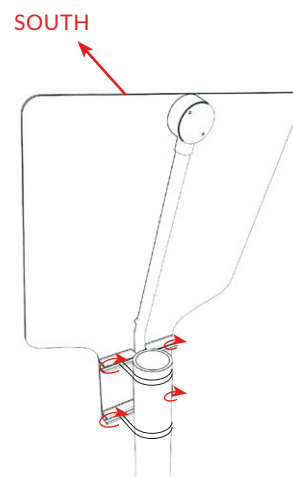

Tighten the module to the pole using channel clamps. ENSURE MODULE IS FACING SOUTH

7

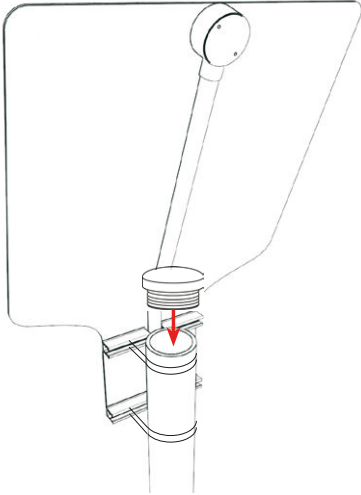

Fit post cap onto column

8

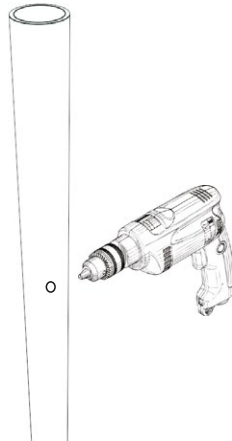

Drill 10mm hole for Alpha Sign Light in required position on column

9

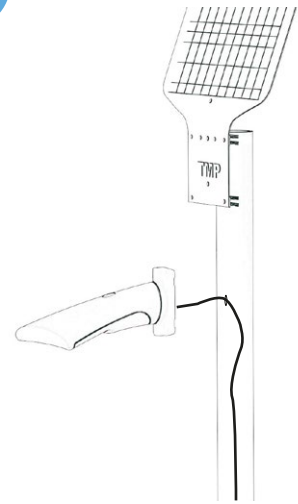

Feed wire from luminaire through hole in the column (use grommet)

10

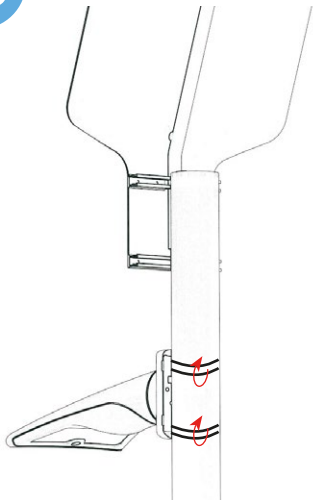

Secure mounting post using Jubilee Clips (not supplied) and tighten

11

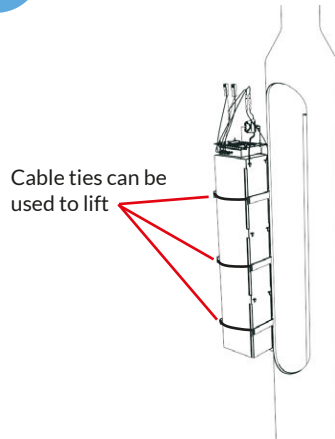

Cable ties can be used to lift

Insert battery pack into column and use hook to hang over back board, TAKE CARE NOT TO DAMAGE BATTERIES

12

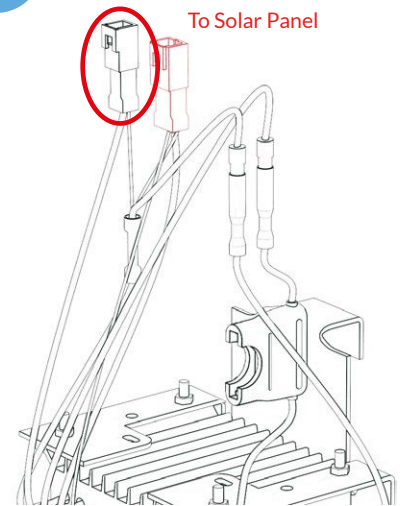

To Solar Panel

Plug in 2 way connector (from Solar Panel)

13

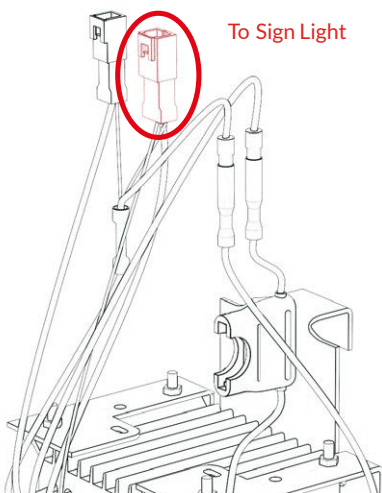

To Sign Light

Plug in 3 way connector (from Alpha Sign Light)

14

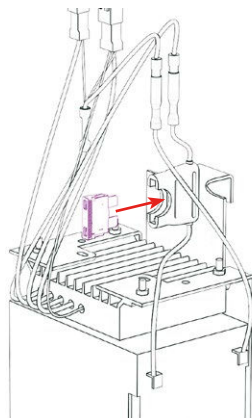

Insert 3A fuse into fuse holder, check lights on the charge controller (after 5 seconds the green LED should be on and the 2 red LEDs should be off)

15

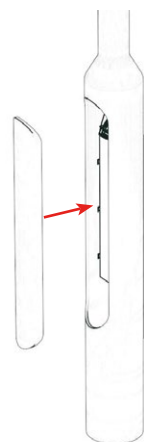

Check operation and fit access cover, ensure adequate ventilation

Commissioning

During Daylight

The green LED should be flashing slowly. Depending upon the battery condition, one of the red LEDs may also be on.

The luminaire should be on. To check the function of the luminaire during daytime, cover the solar module (with cardboard or blanket). After 1 minute the green LED should become solid, and after a further 4 minutes the luminaire should turn on.

During Night Time

The green LED should be on solid (not flashing). Depending upon the battery condition, one of the red LEDs may also be on. The luminaire should be on.

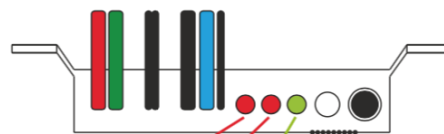

OFF	OFF	OFF	Battery not connected or fuse blown
OFF	OFF	ON	Normal operation : Night-time detected
OFF	OFF	FLASH	Normal operation : Day-time detected
OFF	FLASH		Luminaire fault
ON	OFF	ON	Battery low : luminaire brightness reduced
ON	ON		Fault : reconnect in correct sequence

Note: The system takes up to 1 minute to detect the change between day and night phases, plus an additional 4 minutes for the luminaire to switch on and off. This is to prevent false day and night detection.

Maintenance

Battery Pack

The battery pack is expected to last 3 to 4 years, but this depends on installation location. The battery pack can be easily replaced as follows:

1. Remove the lighting column access cover
2. Disconnect the 2 way plug
3. Disconnect the 3 way plug
4. Remove the fuse from the fuse holder
5. De-couple the bullet crimps from the battery pack
6. Cut the 3 cable ties securing the battery pack in place
7. Refit in the reverse sequence (**always connect the cables before inserting the fuse**)
8. Recheck column ventilation

Solar Panel

The solar module should be periodically inspected for damage. The inspection regime should be set according to prevailing conditions. Systems installed in areas with significant levels of atmospheric pollutants or excessive wind loads should be inspected more regularly.

The module is manufactured on anodised, marine grade aluminium to minimise corrosion. Check that the channel clamps are free from corrosion and that the sign channels are securely fixed to the solar panel.

It is recommended that the front of the module is cleaned during inspection.

Need help? 0208 744 8201